



Proudly supporting Ronald McDonald House Charities Australia.

ASSEMBLY INSTRUCTION SANTO ANDRE FILING CABINET

ITEM CODE - 74554

Imported by Amart Furniture Pty Ltd, Qld, Brisbane Australia.

For any assistance to assembly or for missing parts please phone Amart Furniture, Customer Service Freecall 1800 351 084.

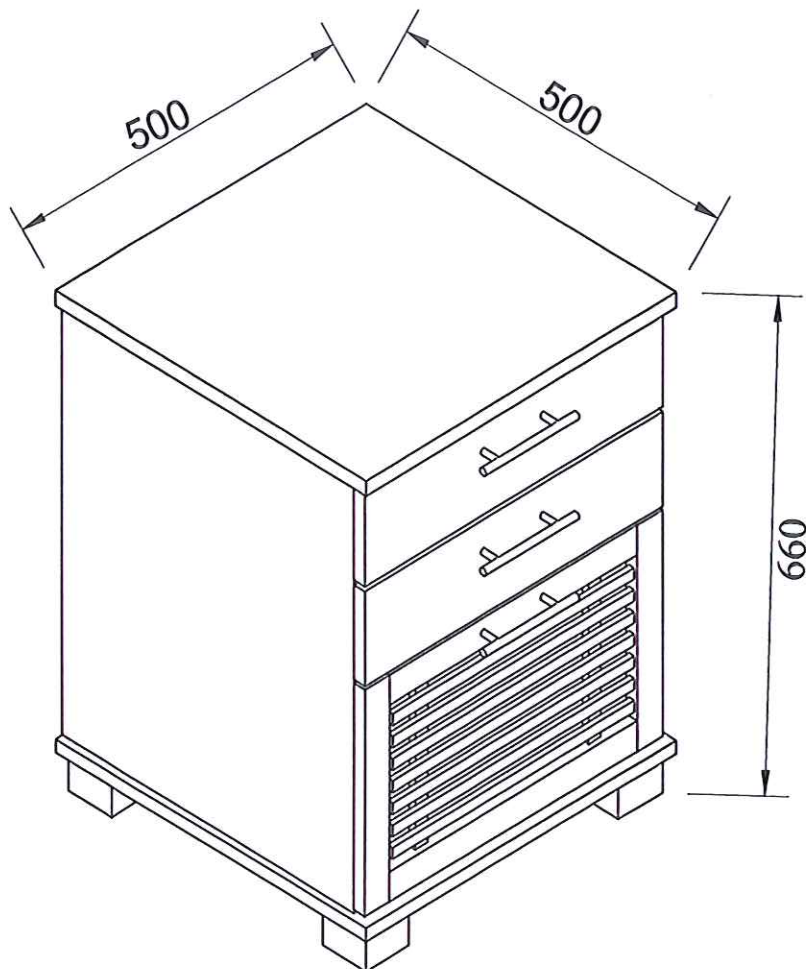



Imported by Amart Furniture Pty Ltd, Brisbane QLD Australia.
For any assistance with assembly or for missing parts please phone
Amart Furniture, Customer Service Free call 1800 351 084

PRE-ASSEMBLY PREPARATION

Before you start:

1. Choose a clean, level, spacious assembly area. Avoid hard surfaces that may damage the product.
2. Take care when lifting. Product should be assembled as near as possible to the point of use.
3. Ensure that you have all required contents for complete assembly.
4. Always read the assembly instructions carefully before beginning assembly.
5. Keep all hardware parts and packaging out of reach of small children.
6. Do not over tighten the screws and bolts as this may damage the threads.

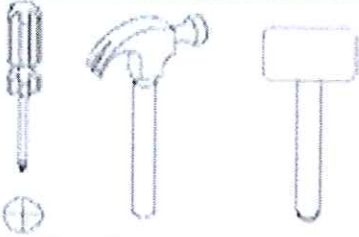
	
ALLOW 30 MINUTES	PEOPLE REQUIRED
	
ADDITIONAL TOOLS REQUIRED	

⚠ WARNING		
		<p>Children have died from furniture tipover.</p> <ul style="list-style-type: none">• ALWAYS secure it with an anchor device.• NEVER allow children to stand, climb or hang on drawers, doors, or shelves.• NEVER open more than one drawer at a time.• Place heavy items down low <p>NEVER put a TV on this furniture </p> <p><small>This is a permanent label. Do not remove!</small></p>

SAFETY BRACKETS INSTRUCTIONS
IF YOUR PRODUCT REQUIRES THE ADDITION OF SAFETY
BRACKETS OR "TIPPING KITS" PLEASE INCLUDE THESE
INSTRUCTIONS BELOW.

1. Attach one Mounting Plate to the wall with the Large Screws. Make sure to attach the Mounting Plate into a stud. If mounting into brick or masonry you will need to acquire wall anchors.
2. Attach the second Mounting Plate to the furniture frame with the Short Screws.
3. Move the furniture to its final position. Thread a Wall Strap through the both Mounting Plates and tighten until snug. Do not over tighten.

HARDWARE

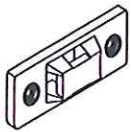

Mounting Plate x 2

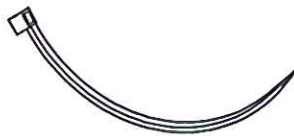

Wall Strap x 1



Large Screw x 2



Small Screw x 2

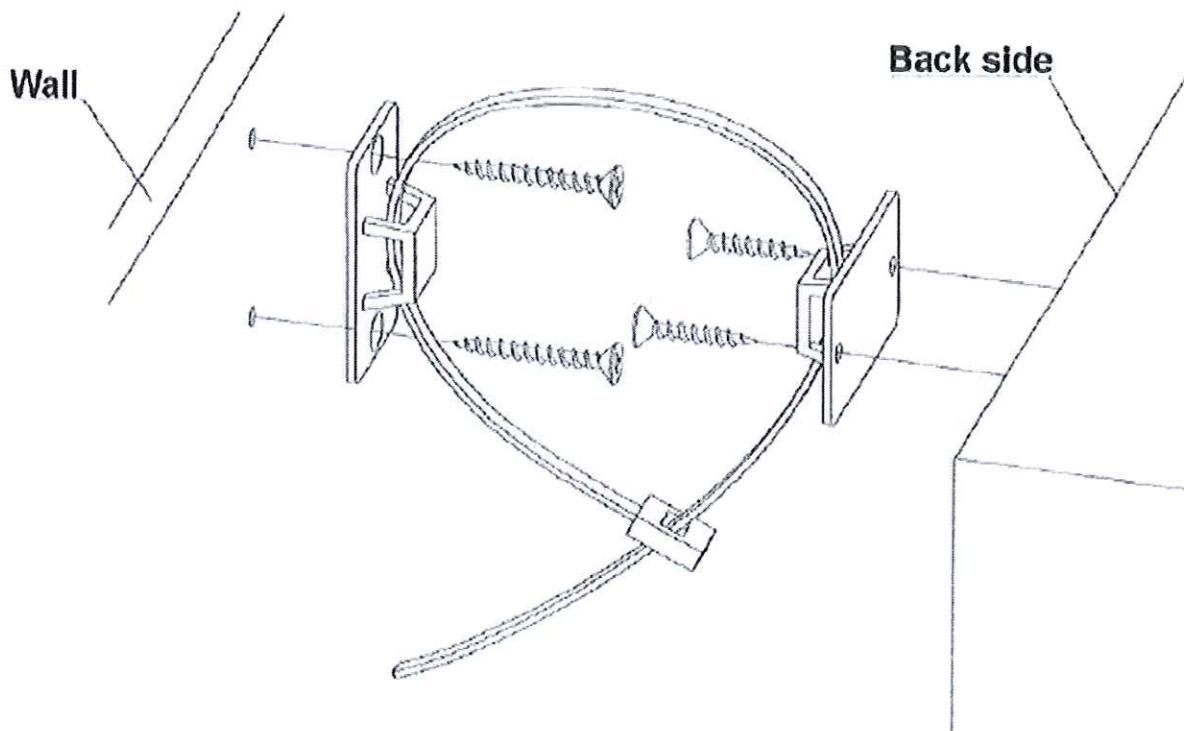

CARE AND MAINTENANCE

PRODUCT CARE FOR HI-GLOSS ITEMS

- Hi-gloss lacquered furniture is more sensitive to marks and scratching than some other furniture products. It is important to exercise caution and care to maximise the life and beauty of this product
- Following the below simple guidelines when using your hi-gloss product will protect your investment for years to come
- Dust frequently with a clean damp lint-free cloth. This will help remove abrasive build up which can damage a finish over time
- Avoid using chemicals or solvents when cleaning the product
- Do not place hot objects on any furniture surface. Always use a hot plate or placemat. Lacquer finishes provide added scratch and heat resistance to our furniture, but they can still be damaged without proper care
- Avoid exposing your furniture to strong sunlight, heat outlet, open windows or dampness. Prolonged exposure to direct sunlight can fade the finish of your furniture, while extreme temperature and humidity changes can cause cracking or splitting
- Do not expose your furniture to any liquids. Never allow water to sit on your furniture. Alcohol, nail polish and perfume are also dangerous as they will dissolve the lacquer finish on contact and may require professional repairs
- Do not allow plastic to come in direct contact with your furniture. Chemicals in the plastic of placemats etc. may soften and mark the finish if left in contact with the furniture for a period of time
- Avoid placing sharp or rough objects on the surface of your furniture. These may scratch the surface of the product
- When moving your furniture, do not drag it across the floor. This may damage the product. Instead use two (2) people to lift carefully from either end